

6' Recycled Plastic Contoured Bench | Surface Mount

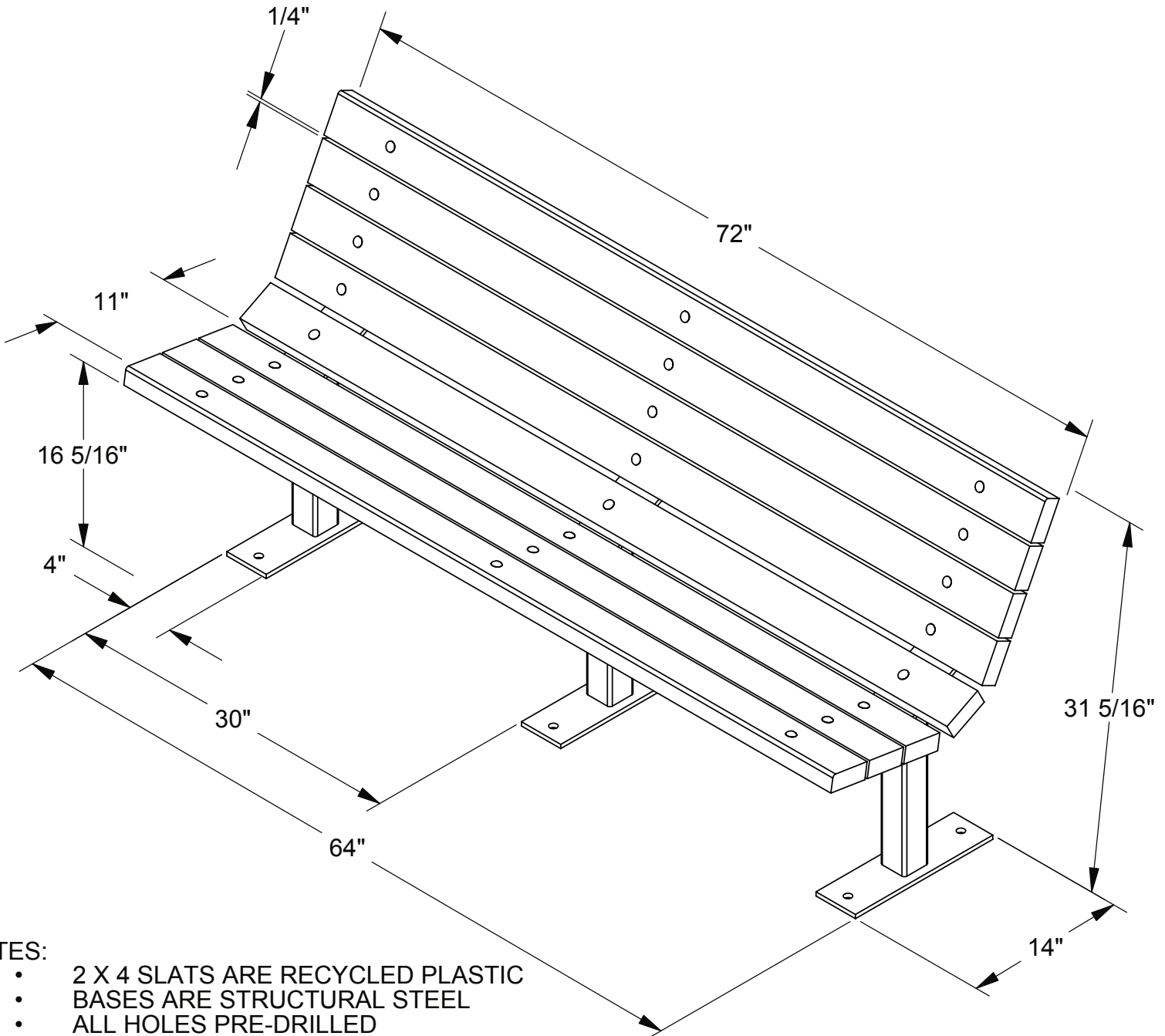

NOTES:

- 2 X 4 SLATS ARE RECYCLED PLASTIC
- BASES ARE STRUCTURAL STEEL
- ALL HOLES PRE-DRILLED
- ALL HARDWARE IS ZINC PLATED (3/8 X 2 1/4 LG. RND HD. BOLT WITH LOCK NUT)
- STAINLESS STEEL HARDWARE AVAILABLE
- UNIT WEIGHT APPROX. 160 LBS.